

SMD Common Mode Inductor Size 9035

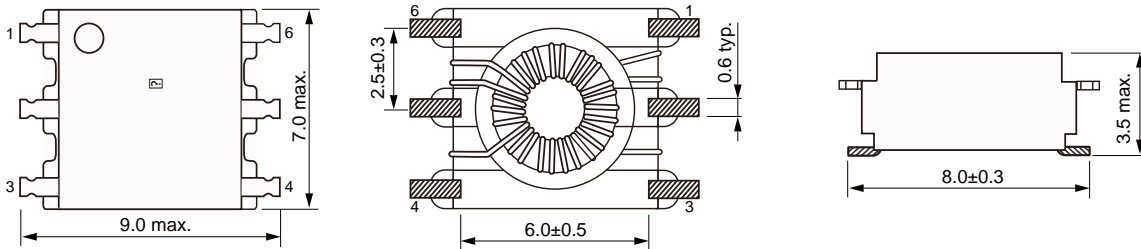

- High current capability up to 450 mA
 - Rated voltage: 80 VDC (42 VAC)
 - Flammability corresponding to UL 94 V-0
 - Operating temperature -40~+125 °C
 - Quantity:1500pcs
-
- USB/CAN/FireWire etc.
 - Signal and sensor lines
 - Power supply systems
 - Suppression of common mode noise

Dimensions: [mm]



Schematic:

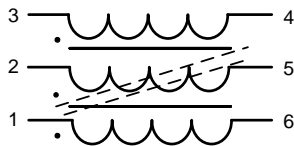

Land Pattern: [mm]

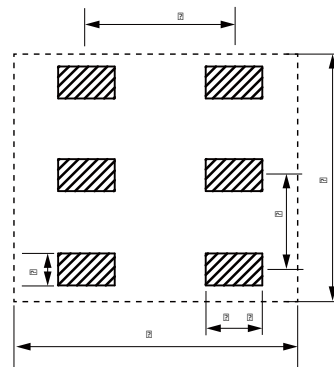

Electrical Properties:

	Inductance @ 100KHz/0.1V 1-6=2-5=3-4		DC Resistance Max. 1-6=2-5=3-4	Rated Current Max. (mA) 1-6=2-5=3-4	Test Max.	Inductance @1MHz/1mA Typ. (nH)	Rated Typ. (V)	Peak Impedance Typ.
□ □ □ □ □	□	□ □ □ □ □	□	□	□ □ □	□		□

Temperature Rise Current: The actual value of DC current when the temperature rise is $\Delta T=40^{\circ}\text{C}$

Typical Electrical Characteristics:

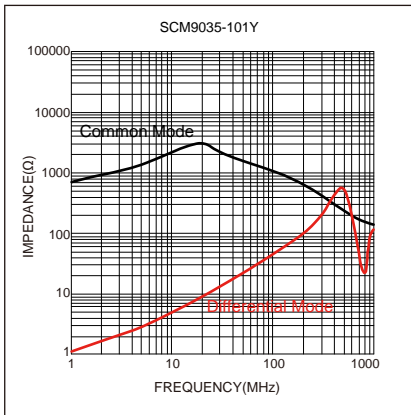

Soldering Reflow:

Preheat condition: 150 ~200°C / 60~180 sec.

Allowed time above 217°C: 60~150 sec.

Max temperature: 260°C.

Max time at max temperature: 10 sec.

Packaging Information:

Tape Dimension:

Series	A0 (mm)	B0 (mm)	D (mm)	P0 (mm)	P1 (mm)	W (mm)	K0 (mm)	E (mm)	T (mm)
SCM9035	6.90± 0.1	9.30± 0.1	1.5± 0.1	4.0± 0.1	12.0± 0.1	16.0± 0.3	3.8± 0.1	1.75± 0.1	0.40± 0.05

Peel force of top cover tape:

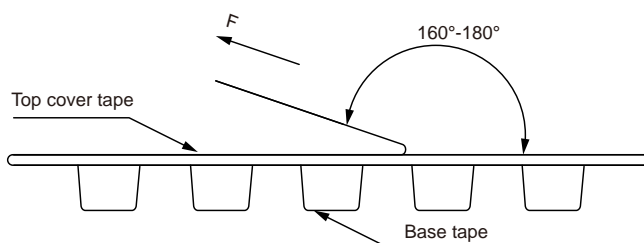

Reel Dimension: [mm]

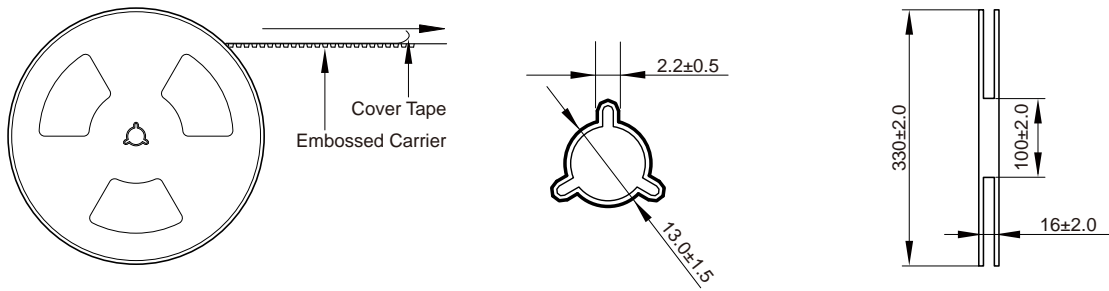

Packaging Quantity:

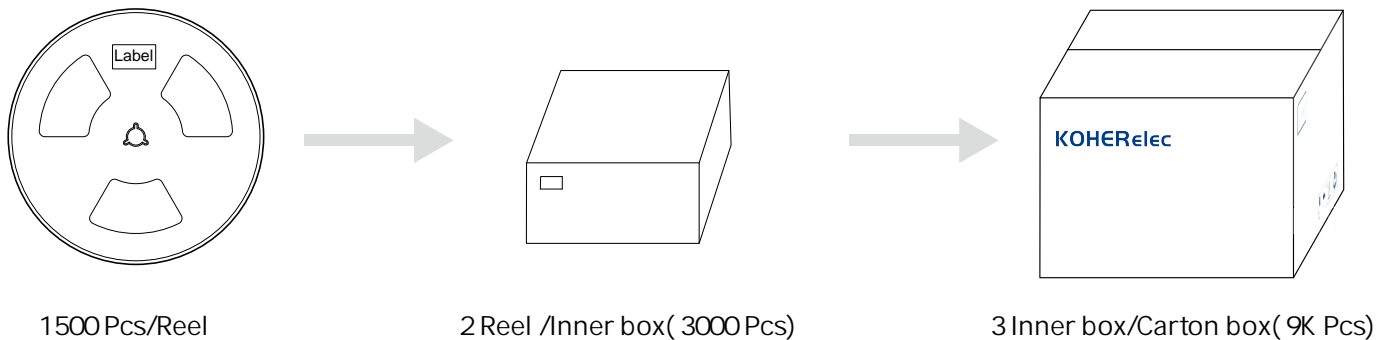

Cautions and Warnings:

Storage Conditions:

- The storage period is within 12 months after the completion of production. Be sure to follow the storage conditions (temperature: -5 to 35°C, humidity: 75% RH Max). If the storage period elapses, the soldering of the terminal electrodes may deteriorate.
- Product should not be exposed to environment with high temperature, high humidity, dust, corrosive gas and etc.
- Products should be handled with care to avoid damage or contamination from perspiration and skin oils.
- Please always handle products carefully to prevent any damage caused by dropping down or inappropriate removing.

Operation Instructions:

- Self heating (temperature increase) occurs when the power is turned ON, so the tolerance should be sufficient for the set thermal design.
- Before soldering, be sure to preheat components. The preheating temperature should be set so that the temperature difference between the solder temperature and chip temperature does not exceed 150°C.
- Soldering corrections after mounting should be within the range of the conditions determined in the specifications. If overheated, a short circuit, performance deterioration, or lifespan shortening may occur.
- Generally, Koher might not be familiar with either customer's specific application or actual requests as customer does. As a result customer shall be responsible for checking and confirming whether Koher product with the performance described in the product specification is suitable for using in customer's particular application or not.