

c
c
c

:

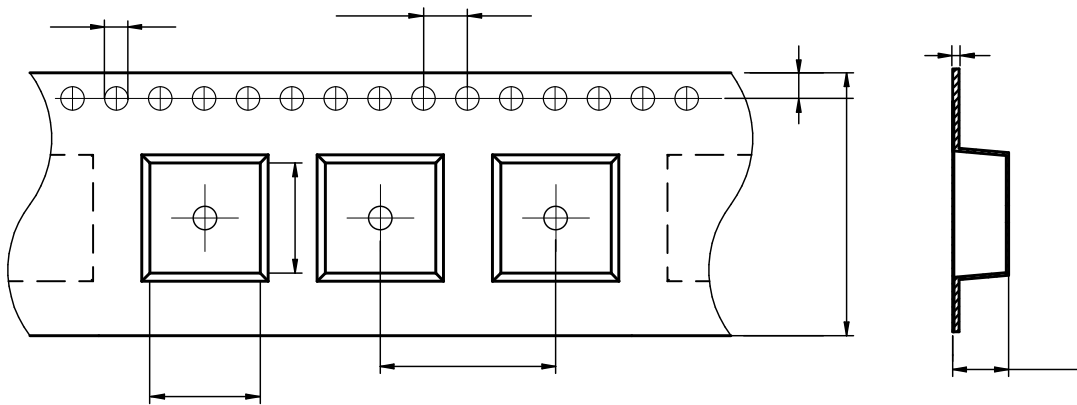

MDA1040HT	10.5±0.1	11.7±0.1	1.5±0.1	4.0±0.1	16.0±0.1	24±0.3	4.4±0.1	1.75±0.1	0.40±0.05
-----------	----------	----------	---------	---------	----------	--------	---------	----------	-----------

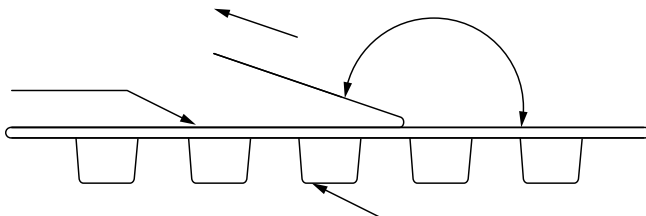

The peel force of top cover tape shall be between 0.1 to 1.3 N

Marking	KH+Printing (Inductance+period)
---------	---------------------------------

:

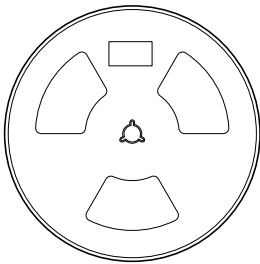
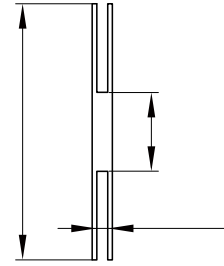
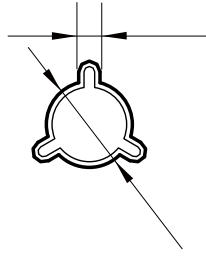
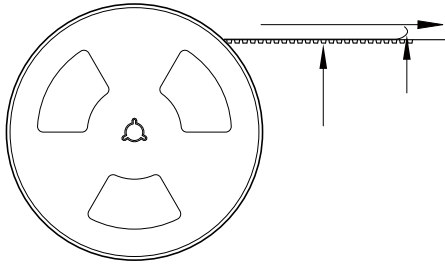

500 Pcs/Reel

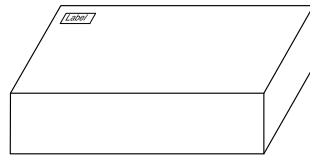

2 Reel /Inner box(1000 Pcs)

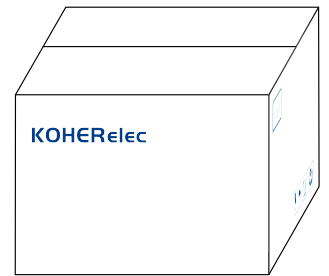

3 Inner box/Carton box(3K Pcs)

:

-
-
-
-
-
-
-
-
-
-