

FBHE S Series



FEATURES

-
-
-
-
-

APPLICATION

-
-

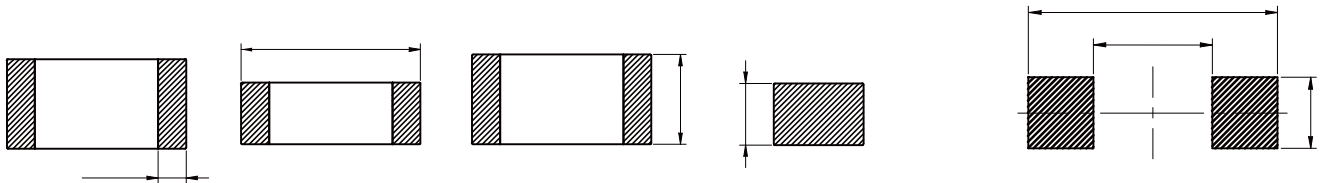

Part No	Impedance @ 100MHz (Ω)	Tolerance	DC Resistance Max. (Ω)	Temperature Rise Current Max. (mA)
		0%		
		0%		
		0%		
		0%		
		0%		
		0%		
		0%		
		0%		



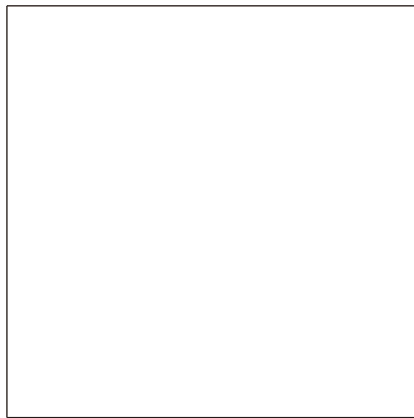
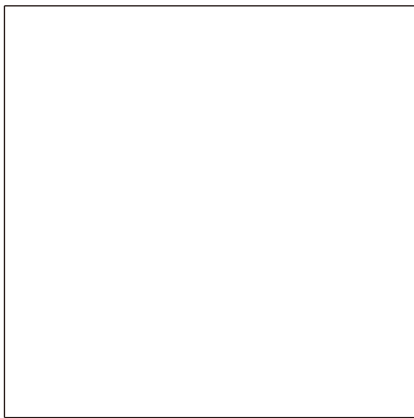
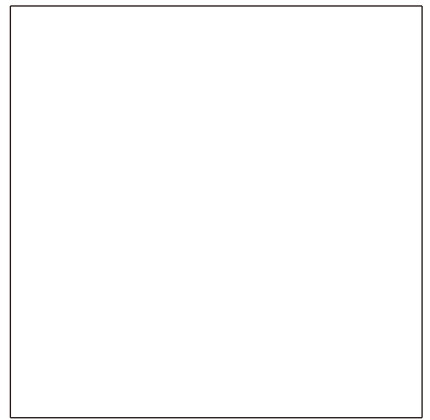
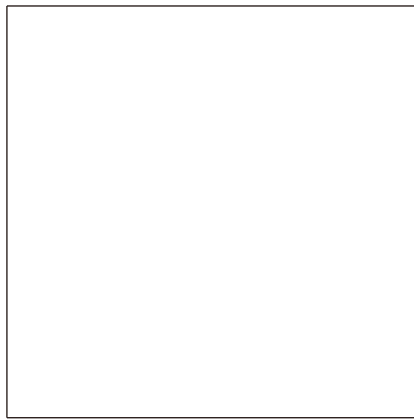
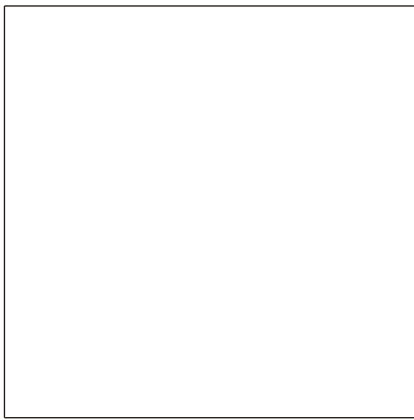
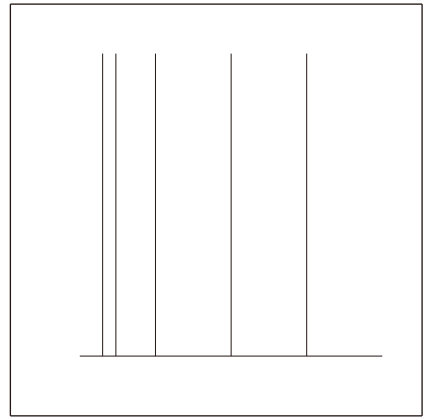
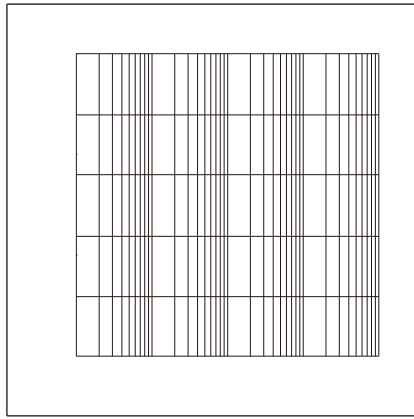
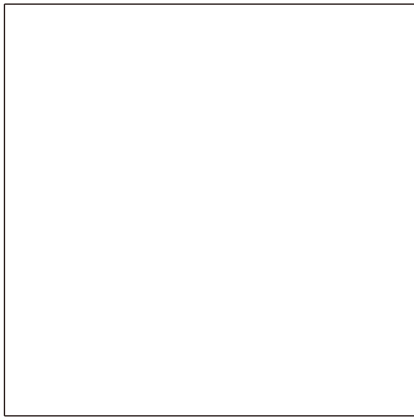

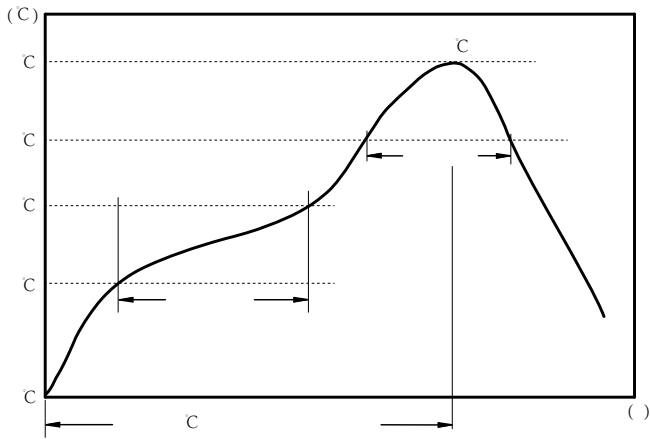

C
C
C

:

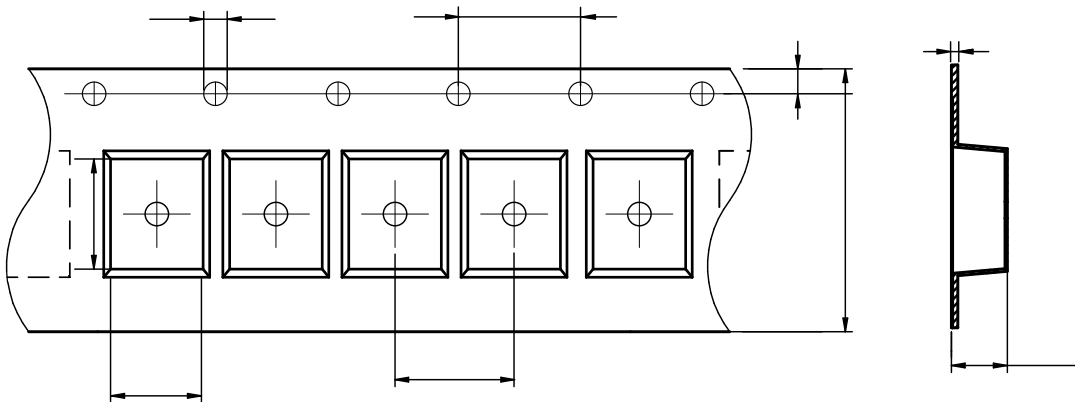

FBHE1206S	1.75± 0.1	3.35± 0.1	1.5± 0.1	4.0± 0.1	4.0± 0.1	8.0± 0.3	1.25± 0.1	1.75± 0.1	0.23± 0.05

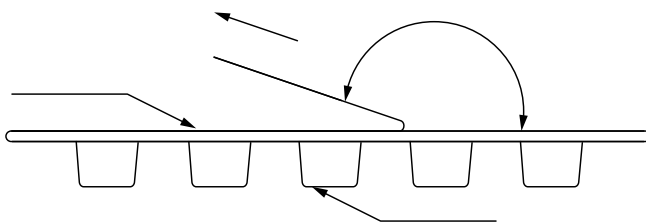

The peel force of top cover tape shall be between 0.14 to 0.58 N

