

# FBE Series



## FEATURES

- 
- 
- 
- 
- 
- 

## APPLICATION

- 
- 

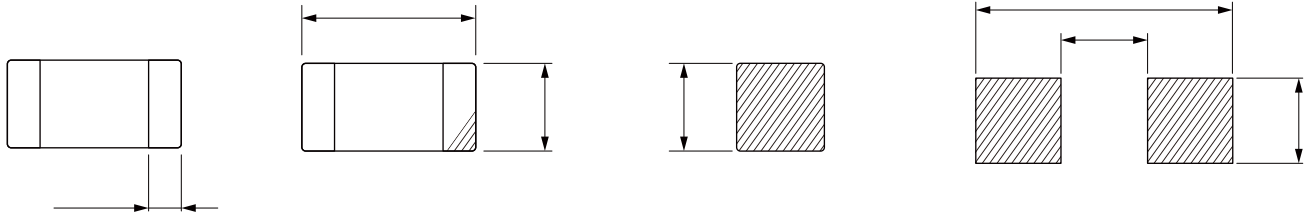

Part No	Impedance @ 100MHz (Ω)	Tolerance	Temperature Rise Current Max. (mA)	DC Resistance Max. (Ω)
FBE0603-100-701R	10	±25%	700	0.20
FBE0603-300-601R	30	±25%	600	0.25
FBE0603-300-701R	30	±25%	700	0.20
FBE0603-600-601R	60	±25%	600	0.30
FBE0603-600-701R	60	±25%	700	0.20
FBE0603-800-401R	80	±25%	400	0.30
FBE0603-101-301R	100	±25%	300	0.20
FBE0603-121-301R	120	±25%	300	0.40
FBE0603-121-601R	120	±25%	600	0.25
FBE0603-151-301R	150	±25%	300	0.40
FBE0603-151-601R	150	±25%	600	0.25
FBE0603-221-251R	220	±25%	250	0.60
FBE0603-221-551R	220	±25%	550	0.30
FBE0603-301-201R	300	±25%	200	0.80
FBE0603-301-501R	300	±25%	500	0.35
FBE0603-471-201R	470	±25%	200	0.85
FBE0603-471-351R	470	±25%	350	0.45
FBE0603-601-151R	600	±25%	150	1.20

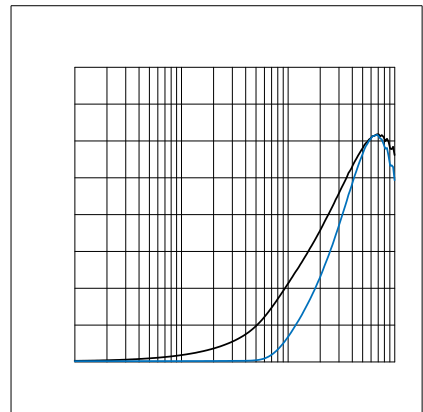
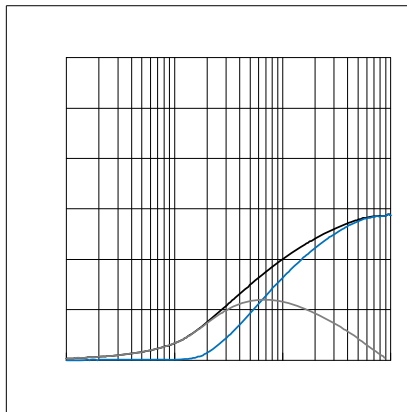
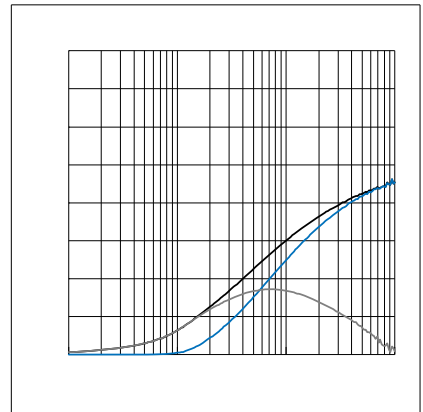

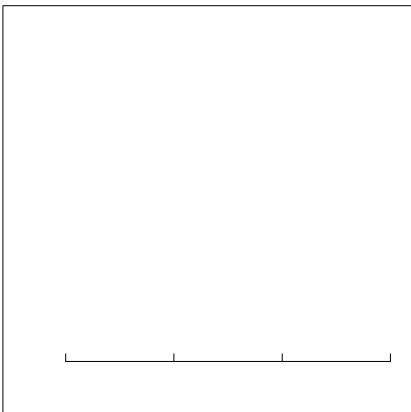
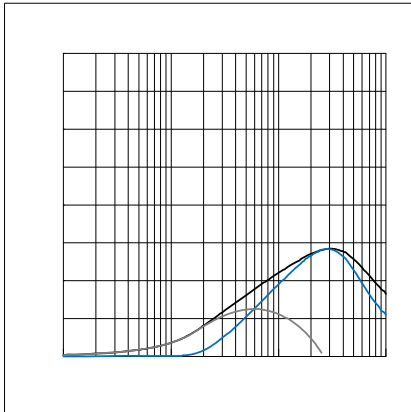

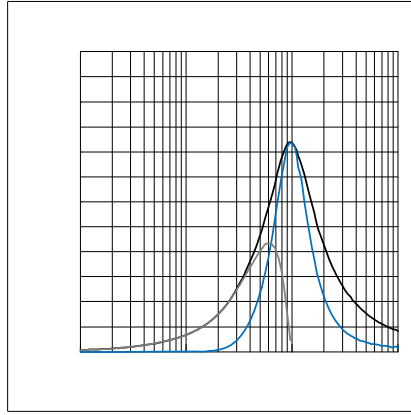
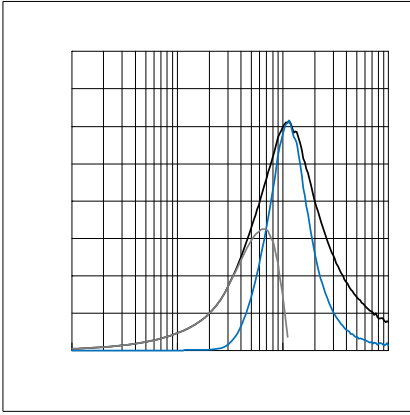

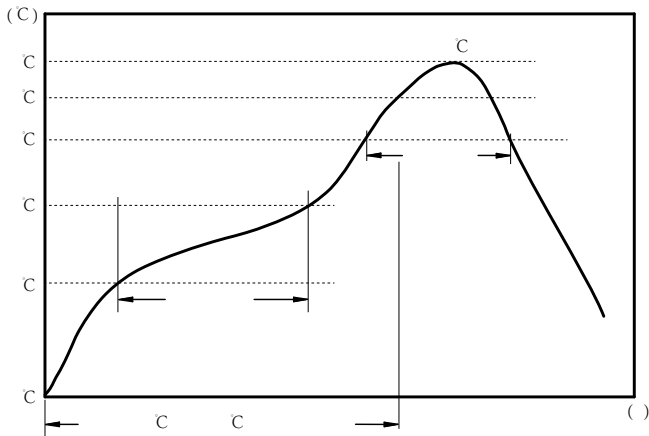

C  
C  
C

:

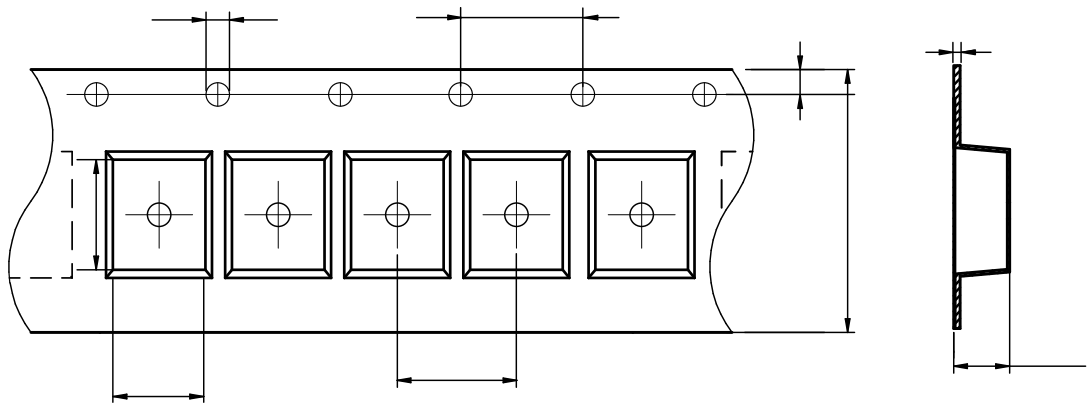

FBE0603	0.96±0.05	1.80±0.05	1.5±0.1	4.0±0.1	4.0±0.1	8.0±0.3	0.95±0.1	1.75±0.1	0.95±0.05
---------	-----------	-----------	---------	---------	---------	---------	----------	----------	-----------

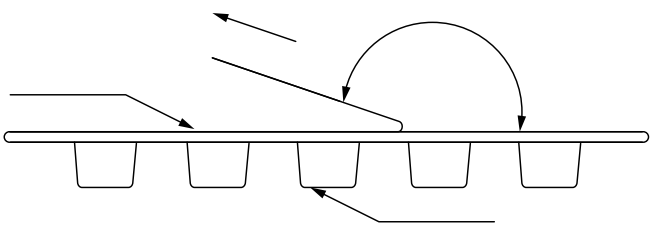

The peel force of top cover tape shall be between 0.14 to 0.58 N

:

