

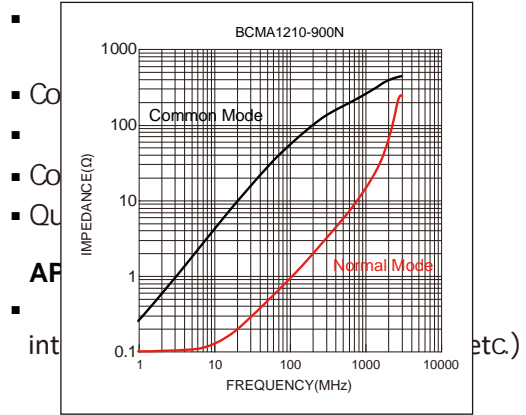

BCMA Series

Common Modas Filters For Automotive Signal Line Size 1210

FEATURES



Dimensions: [mm]

Land Pattern: [mm]

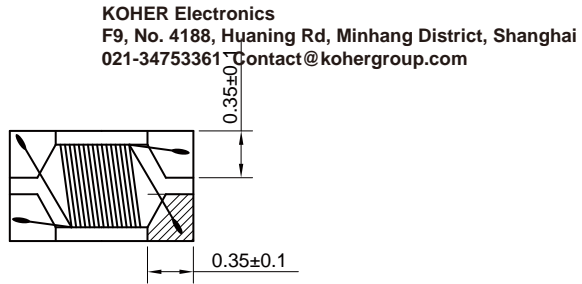
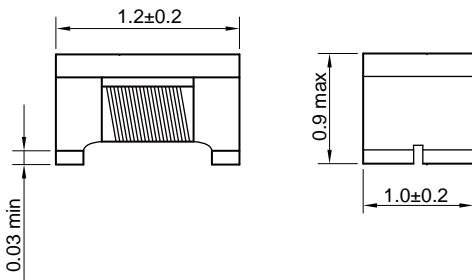

Electrical Properties:

Typical Electrical Characteristics:

Soldering Reflow:

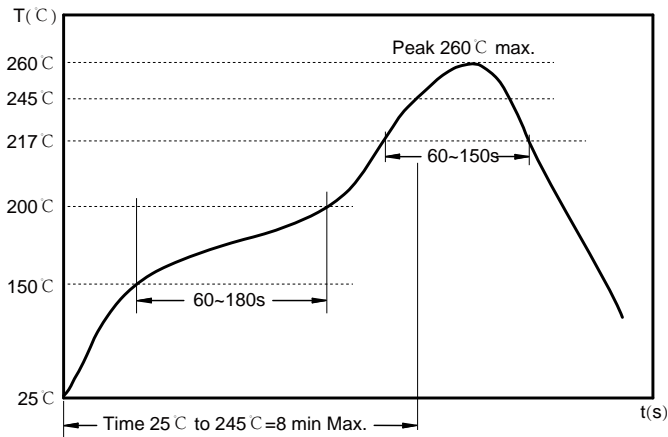

Preheat condition: 150 ~200°C / 60~180 sec.

Allowed time above 217°C: 60~150 sec.

Max temperature: 260°C.

Max time at max temperature: 10 sec.

Allowed Reflow time: 3x max.

Packaging Information:

Tape Dimension:

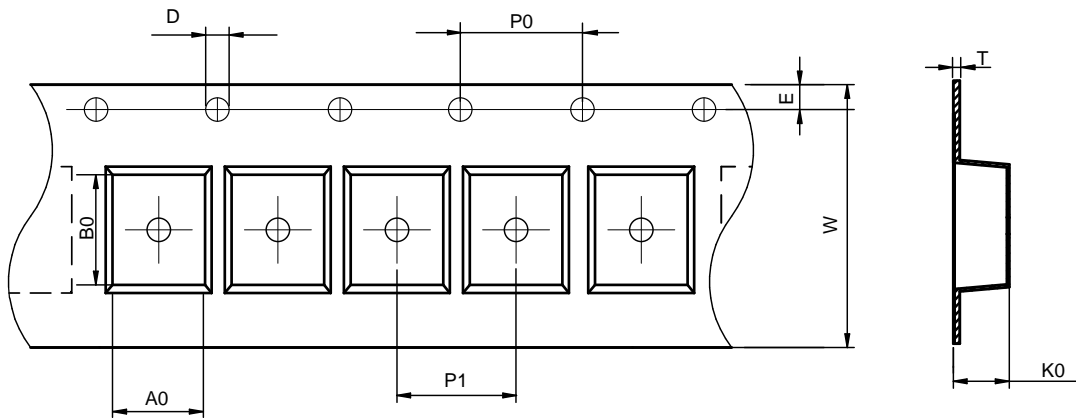

Series	A0 (mm)	B0 (mm)	D (mm)	P0 (mm)	P1 (mm)	W (mm)	K0 (mm)	E (mm)	T (mm)
BCMA1210	1.12±0.1	1.40±0.1	1.5±0.1	4.0±0.1	4.0±0.1	8.0±0.3	1.05±0.1	1.75±0.1	0.22±0.05

Peel force of top cover tape:

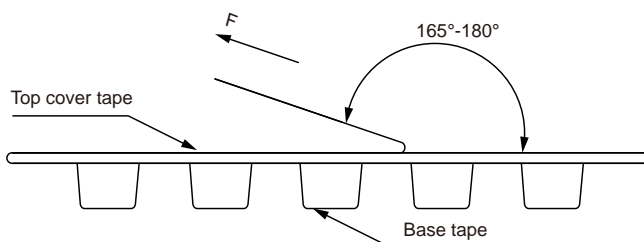

The peel force of top cover tape shall be between 0.15 to 0.78 N

Reel Dimension: [mm]

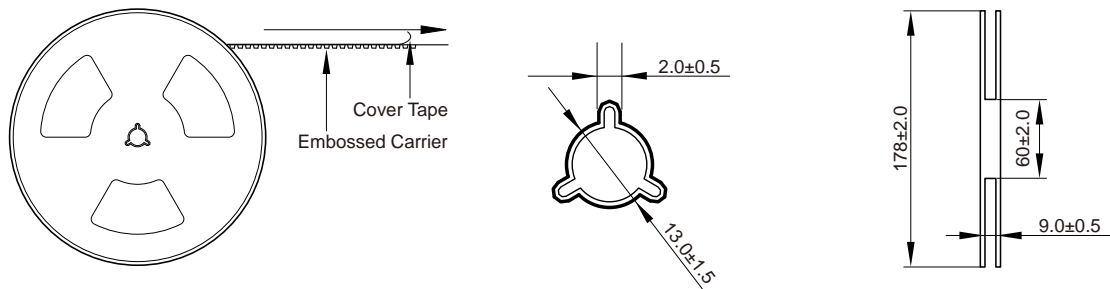

Packaging Quantity:

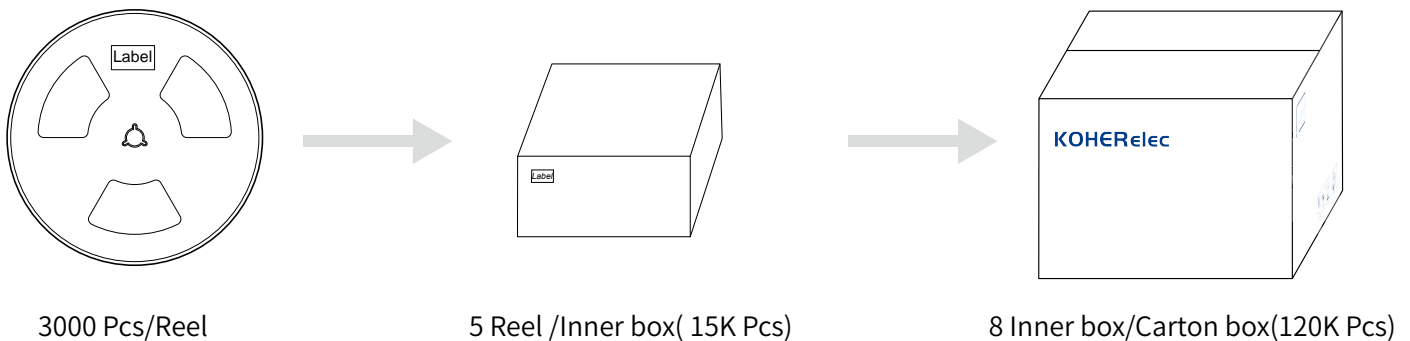

Cautions and Warnings:

Storage Conditions:

- The storage period is within 12 months after the completion of production. Be sure to follow the storage conditions (temperature: -5 to 35°C, humidity: 75% RH Max). If the storage period elapses, the soldering of the terminal electrodes may deteriorate. The warranty period is one year.
- Product should not be exposed to environment with high temperature, high humidity, dust, corrosive gas and etc.
- Products should be handled with care to avoid damage or contamination from perspiration and skin oils.
- Please always handle products carefully to prevent any damage caused by dropping down or inappropriate removing.

Operation Instructions:

- Self heating (temperature increase) occurs when the power is turned ON, so the tolerance should be sufficient for the set thermal design.
- Before soldering, be sure to preheat components. The preheating temperature should be set so that the temperature difference between the solder temperature and chip temperature does not exceed 150°C.
- Soldering corrections after mounting should be within the range of the conditions determined in the specifications. If overheated, a short circuit, performance deterioration, or lifespan shortening may occur.
- Generally, Koher might not be familiar with either customer's specific application or actual requests as customer does. As a result customer shall be responsible for checking and confirming whether Koher product with the performance described in the product specification is suitable for using in customer's particular application or not.